

# Freedom

Boom Accessory Guide

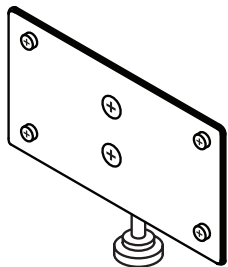

# Rail Mounted Accessories



**H8-200-37-1**  
Ophthalmoscope mount

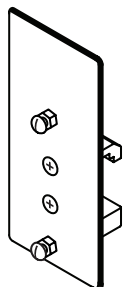

**H8-200-98**  
Ophthalmoscope tip holder

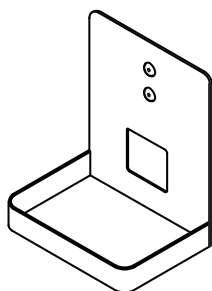

**H8-201-00**  
Rail mounted tray for Welch Allen charger

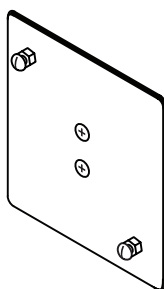

**H8-200-97**  
Rail mounted bracket for Welch Allen Sure-Temp Thermometers

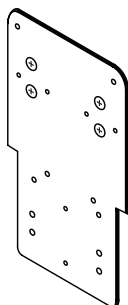

**H8-200-42-1**  
Sharps holder

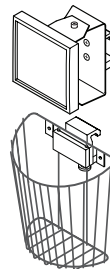

**H8-200-95**  
Rail mounted Manometer with BP cuff basket

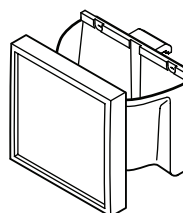

**H8-200-95-1**  
BP Cuff basket only

**H8-200-94**  
Rail mounted Manometer with built-in BP cuff holder

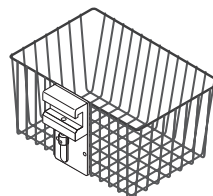

**H8-200-09-A**  
Basket 8" x 12" x 6"

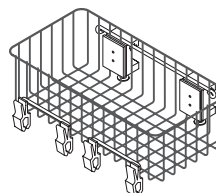

**H8-200-31-1**  
Bottom mount basket 13" x 6 1/2" x 4" with 4 supply clips



**H8-200-36-1**  
Chart holder

# Rail Mounted Accessories

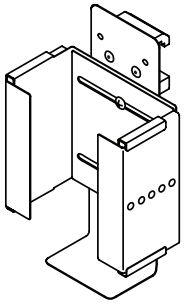

**H8-200-41-1 Single**  
**H8-200-41-3 Triple**  
Glove box holder

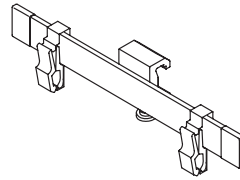

**H8-200-46-1**  
Double supply clip

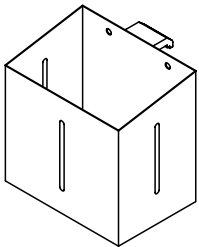

**H8-200-88-1**  
Utility storage box

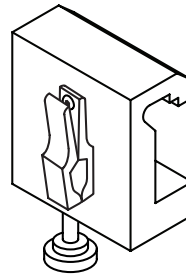

**H8-200-46-2**  
Single supply clip

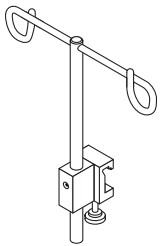

**H8-200-83**  
IV Pole, 12" with holder

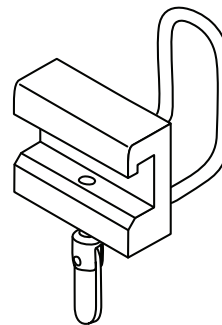

**H8-200-10-A**  
Hook for headlight

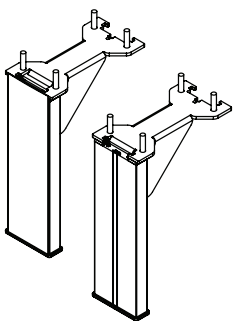

**4A-EXF-12**  
12" Front Column Extension  
**4A-EXF-24**  
24" Front Column Extension  
**4A-EXB-12**  
12" Back Column Extension  
**4A-EXB-24**  
24" Back Column Extension

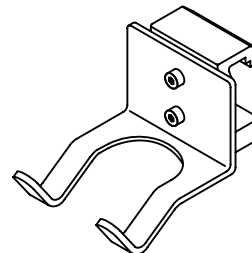

**H8-200-43-1 Adult**  
**H8-200-43-2 Pediatric**  
Resuscitation bag holder

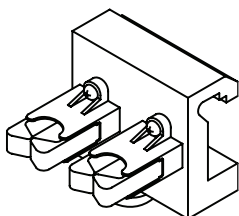

**H8-200-45-1**  
Double tubing clip

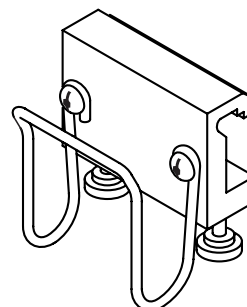

**H8-200-10-A**  
4" Rail mounted cable holder

# Rail Mounted Accessories

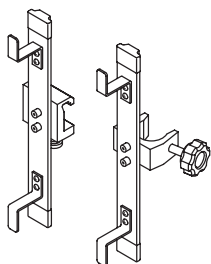

**H8-200-38-1**  
Cord wrap rail mounted  
**H8-200-38-2**  
Cord wrap pole mounted

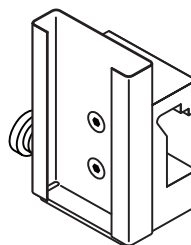

**H8-200-07**  
Vacuum slide, rail mount

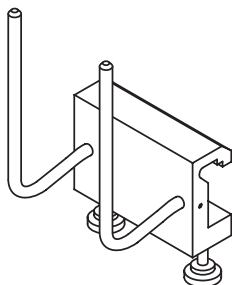

**H8-200-32-1**  
Dual hook

# Channel Mounted Accessories

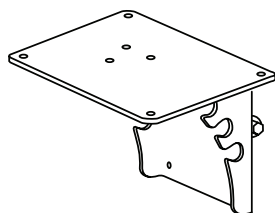

**4A-VESA-PMO**  
Patient monitor bracket for Philips and Nihon Kohden bottom mounts, 4FVB-1 required

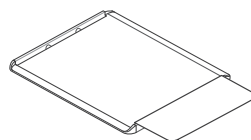

**4A-SHF-48**  
Shelf extension set, 8" per side for endoscopy scope

**4A-FPH-17**  
**4A-FPH-22**  
Foot pedal holder

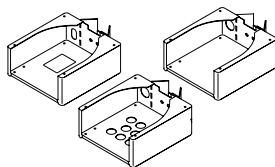

**4A-HSKV-17**  
Skyvac holder

**4A-SUH-17**  
**4A-SUH-22**  
Supply holder

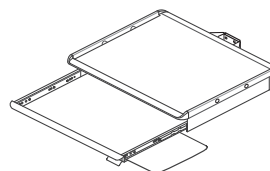

**4A-PUS-22**  
22" Pullout write shelf  
**4A-PUK-22**  
22" Pullout keyboard tray with L/R mouse holder

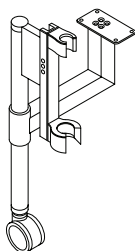

**4A-SDOB**  
Streamline docking bracket

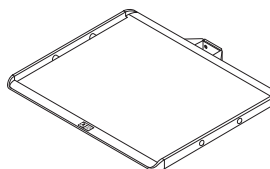

**4A-SHC-17**  
17" Column shelf  
**4A-SHC-22**  
22" Column shelf  
**4A-SHC-32**  
32" Column shelf

# Channel Mounted Accessories

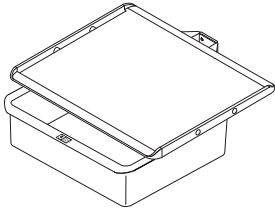

## 4A-BD-1-22-C

Single budget column drawer with 22" shelf

## 4A-BD-2-22-C

Double budget column drawer with 22" shelf

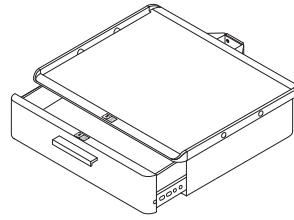

## 4A-PD-17-17

17" Premium drawer with 17" shelf

## 4A-PD-22-22

22" Premium drawer with 22" shelf

## 4A-PD-22-32

22" Premium drawer with 32" shelf

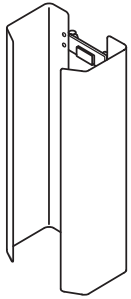

## 4A-BCC-37

Back cover for 4VBC-37/4CMC-37 only

## 4A-BCC-49

Back cover for 4VBC-49/4CMC-49 only

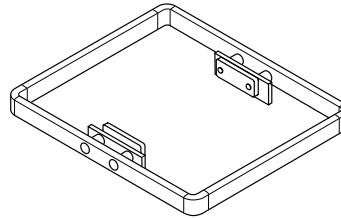

## 4A-ERW-W

Wraparound equipment rail for wide column

## 4A-ERW-C

Wraparound equipment rail for compact column

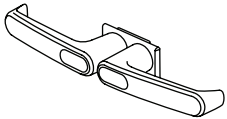

## 4A-HAC

Handle, column connection

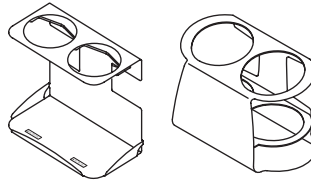

## 4A-BHCO

CO2 bottle holder for two "E" cylinders

## 4A-BHUA

Universal bottle holder, adjustable

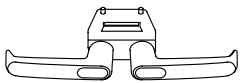

## 4A-HAS

Handle, shelf connection

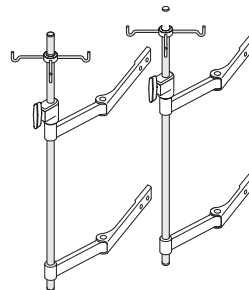

## 4A-IVE-C

Extendable wing bar for compact carriers, with IV hooks

## 4A-IVE-W

Extendable wing bar for wide carriers, with IV hooks

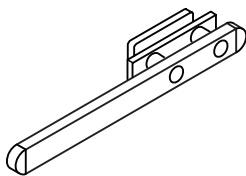

## 4A-ERCA-9

9" Equipment rail for Skytrack, offset

## 4A-ERSB-13

13" Equipment rail for side bar inside mount (T-nut)

## 4A-ERCA-13

13" Equipment rail for Skytrack, offset

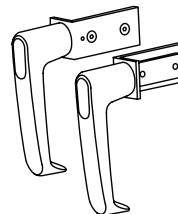

## 4A-HAB

Handle, sidebar connection

# Channel Mounted Accessories

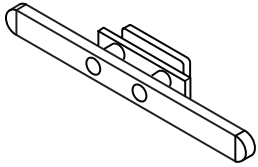

## 4A-ERCS-10

10" Equipment rail for Skytrack, centered

## 4A-ERCS-15

15" Equipment rail for Skytrack, centered

## 4A-ERCS-20

20" Equipment rail for Skytrack, centered

## 4A-ERCS-30

30" Equipment rail for Skytrack, centered

## 4A-ERSH-17

17" Equipment rail for front of shelf

## 4A-ERSH-32

32" Equipment rail for front of shelf

## 4A-ERSH-22

22" Equipment rail for front of shelf

# Smoke-E-Vac Accessories

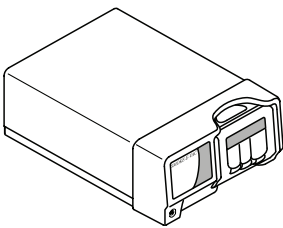

## SMOKE-E-VAC

Smoke evacuation system for Ergon 2 and 3. Requires mounting bracket

## AIR SAFE

Filter for Smoke-e-vac system, 35 hour 2 pack

## EZLINK

Automatic activation device for Smoke-e-vac

## 4A-HSKV-17

Mounting bracket for Smoke-e-vac system, mounts to shelf track

# GCX Support Solutions

Please refer to the Model ID booklet for list of current monitor arms, patient monitor solutions, and keyboard mounts.

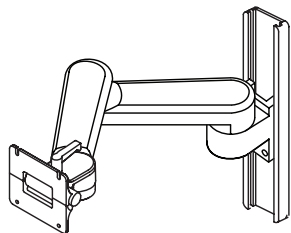

## Monitor Mount

Flat-screen monitor mounts  
Patient monitor mounts

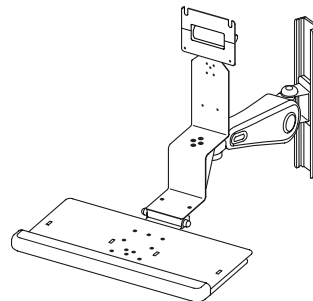

## Multi-Purpose Mount

Monitor / keyboard mounts  
Keyboard mounts

# Horizontal Box Accessories

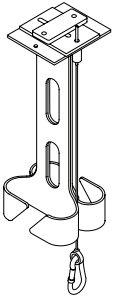

## 4A-CA-UB

Cable organizer  
4UBW  
4UBC

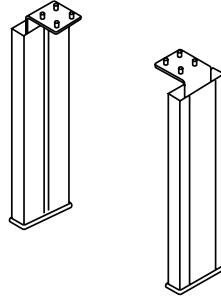

## 4A-EXU-12

12" Box extension

## 4A-EXU-24

24" Box extension for 17" and 22"  
box shelves

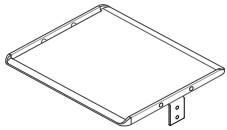

## 4A-SHB-17

17" Box shelf

## 4A-SHB-22

22" Box shelf

12" or 22" extension required

## 4A-SHT-17

17" shelf above box

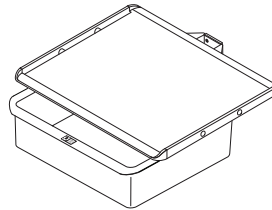

## 4A-BD-1-22-B

Single budget box drawer

## 4A-BD-2-22-B

Double budget box drawer

# Display Accessories

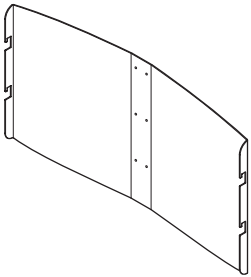

All require 4FXS-XX frame

## 4A-FXS-BC72

72" Large display frame back covers

## 4A-FXS-BC66

66" Large display frame back covers

## 4A-FXS-BC60

60" Large display frame back covers

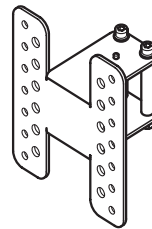

## 4A-BUD

Back up display mounts (set of  
2), requires 4A-PFXX or 4FXS-XX

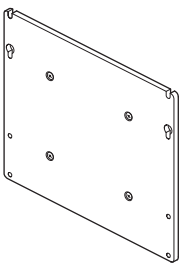

## 4A-VESA

VESA adapter plate, includes  
100x100, 100x200, 200x200



# Circle of Clinical Solutions

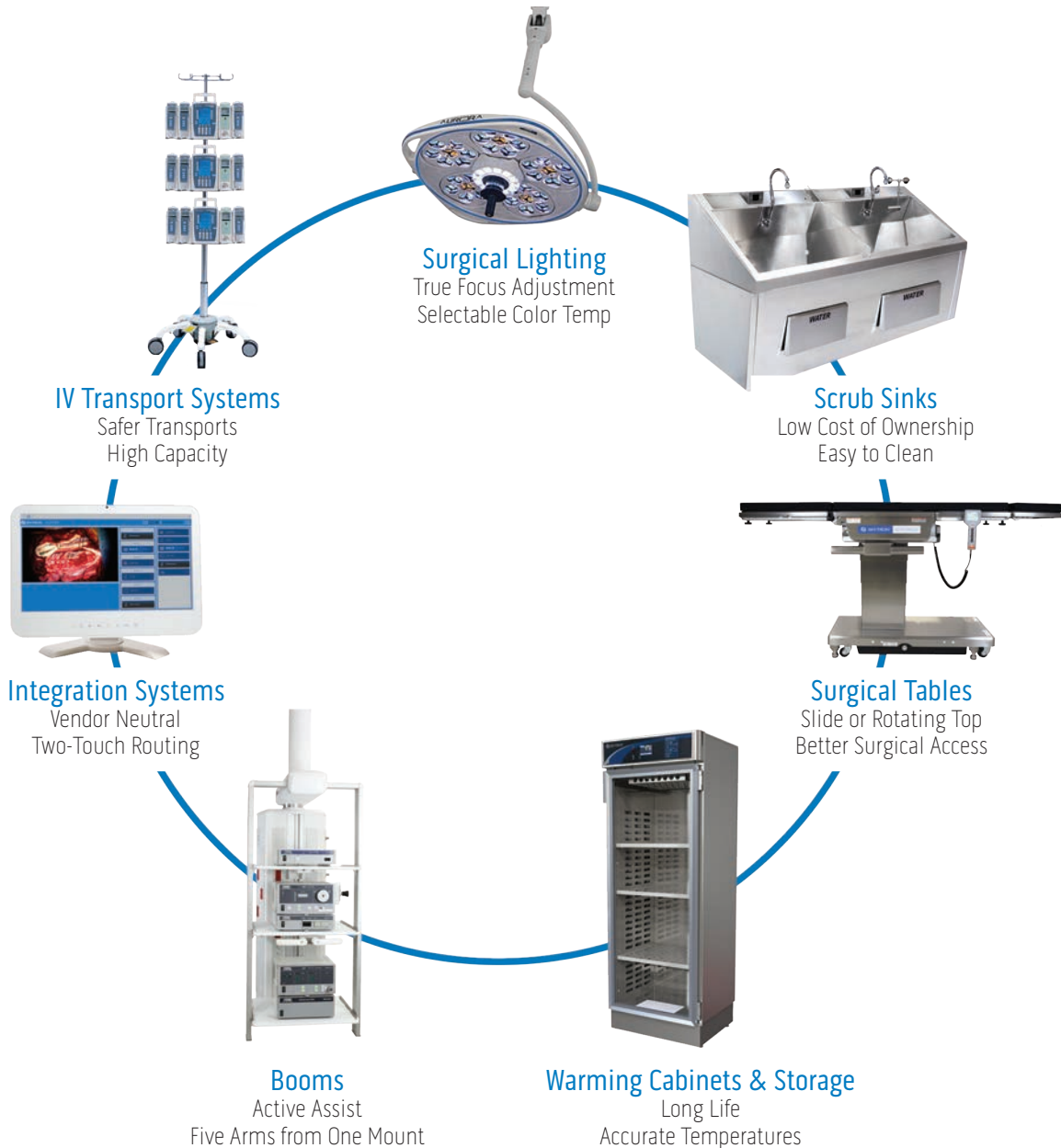

Skytron is the Healthcare Efficiency Specialist, providing full-room solutions of capital equipment, architectural and real-time information systems for Medical, Surgical, Sterile Processing, and Infection Prevention. Our solutions enhance the utilization of people, facilities, and capital because they are designed with the user in mind and have a low, long-term cost of ownership.

To learn more, visit our website at [www.skytron.com](http://www.skytron.com)



5085 Corporate Exchange Blvd. SE  
Grand Rapids, MI 49512  
1.800.SKYTRON (759-8766)  
email: [info@skytron.com](mailto:info@skytron.com)  
[www.skytron.com](http://www.skytron.com)



REV1 3-21  
PN L2-010-206